



# Reusable Respirators

For prolonged periods of use, Half and Full Face Masks by 3M offer exceptional value and quality, all combine comfort with ease of use. 3M™ Respirators have to pass strict quality control tests and provide a consistently high level of safety.

The choice of the right mask and filter type depends on your particular working environment and individual requirements. 3M can assist you to choose the protection that helps you achieve optimum results.



## The 4-Step Method

### 1. Identify the Hazards

Application	Hazard	Typical Protection
Painting, Spraying, Varnishing, Coating	Solvent-Based Paint**	A2P3 R
	Anti-Fouling Paint Spraying / Grinding	A2P3 R
	Water Soluble Paint	A1P2 R
	Solvents, Resins, Synthetic Resins**	A2P3 R
	Latex-Paint, Residual Solvents	A2P3 R
	Wood Preservatives	A1P2 R
Maintenance	Disinfection, Cleaning*	ABEK1P2 R
Decoration	Spray-On Glue, Foam, Varnish, Adhesive	A1P2 R
Waste Removal	Bacteria, Spores, Odours	A1P2 R
Agriculture	Pesticides, Insecticides	ABEK1P2 R
Wood Treatment	Bonding, Spray-On Glue	A2P3 R
Construction, Grinding, Cutting, Drilling	Tarring	A2P3 R
	Sealing	A1P2 R
	Spray Foam Insulation	A1P2 R
Coating	Organic Solvent/with boiling point less than 65 C	AXP3 R
	Ammonia Based Paint Remover	ABEK
	Polyurethane Coating**	ABEK1P3 R
	Solvent Based Varnish	A2
	Water Based Varnish	A1
Bonding	Solvent containing Adhesives	A1
Handling	Sulphur Dioxide	ABE
	Hydrochloric Acid	ABE
	Liquid Manure	ABEK
	Ammonia	K
	Formaldehyde	A1 + Form
	Hazardous goods storage/transport	ABEK1P3 R

**Warning:**

This guide is only an outline. It should not be used as the only means for selecting a respirator. Details regarding performance and limitations are set out on the respirator package and user instructions. Before using any of these respirators, the wearer must read and understand the user instructions for each product. Specific country legislation must be observed.

\* excluding Formaldehyde

\*\* for occurrence of Isocyanates, please contact the 3M Customer Helpline +44 (0) 870 60 800 60 or your local 3M office



- White – Particulate Protection
- Brown – Organic Vapours Protection
- Grey – Inorganic Vapours Protection
- Yellow – Acid Gases Protection
- Green – Ammonia and its Derivatives



## 2. Assess the Risk

Nominal Protection Factors (NPF) for reusable half and full face masks\*







Filter Classification	NPF* with 3M Half Mask	NPF* with 3M Full Face Mask
P1	4	5
P2	12	16
P3	48	1000
Class 1 Gas and Vapour filters	50 or 1000ppm (whichever is lower)	2000 or 1000ppm (whichever is lower)
Class 2 Gas and Vapour filters	50 or 5000ppm (whichever is lower)	2000 or 5000ppm (whichever is lower)

AX-Filter for low boiling point (organic composition with a low boiling point under 65 °C). AX-Filter should only be fitted to 3M™ Full Face masks. AX filters may only be used for a single shift.  
 A1 and A2 Filter for organic vapour with a boiling point above 65 °C.

\* Country APF should be used where available.

Nominal Protection Factor (NPF) - a number derived from the maximum percentage of total inward leakage permitted in relevant European Standards for a given class of respiratory protective devices.

## 3.1 Select the Right Respirator

3M™ Reusable Respirator Series	4000	6000	6500	7500	6000	7907S
						
	Half Masks	Half Masks	Half Masks	Half Masks	Full Face Masks	Full Face Masks
Durable		●	●	●	●	●
Maintenance-free	●					
Ready to use	●					
Comfortable	●	●	●	●	●	●
Lightweight	●	●	●	●	●	●
Easy to fit	●	●	●	●	●	●
Adjustable head bands	●	●	●	●	●	●
Drop Down feature			● (QL)	●		
Easy-to-clean		●	●	●	●	●
Quick de-assembly for maintenance			●	●		
3M™ Cool Flow Valve			●	●	●	
Compatible with 3M Supplied Air System		●	●	●	●	●
Modular replacement filter system		●	●	●	●	●
Variety of filters	●	●	●	●	●	●
Eye Protection					●	●
Six-point head harness						●
Speaking diaphragm						●
Spare parts		●	●	●	●	●
Accessories	●	●	●	●	●	●
Multiple sizes available		●	●	●	●	
Colour coded sizes		●		●	●	

# 3M™ Reusable Respirators



## 3.2 Select the Right Filter

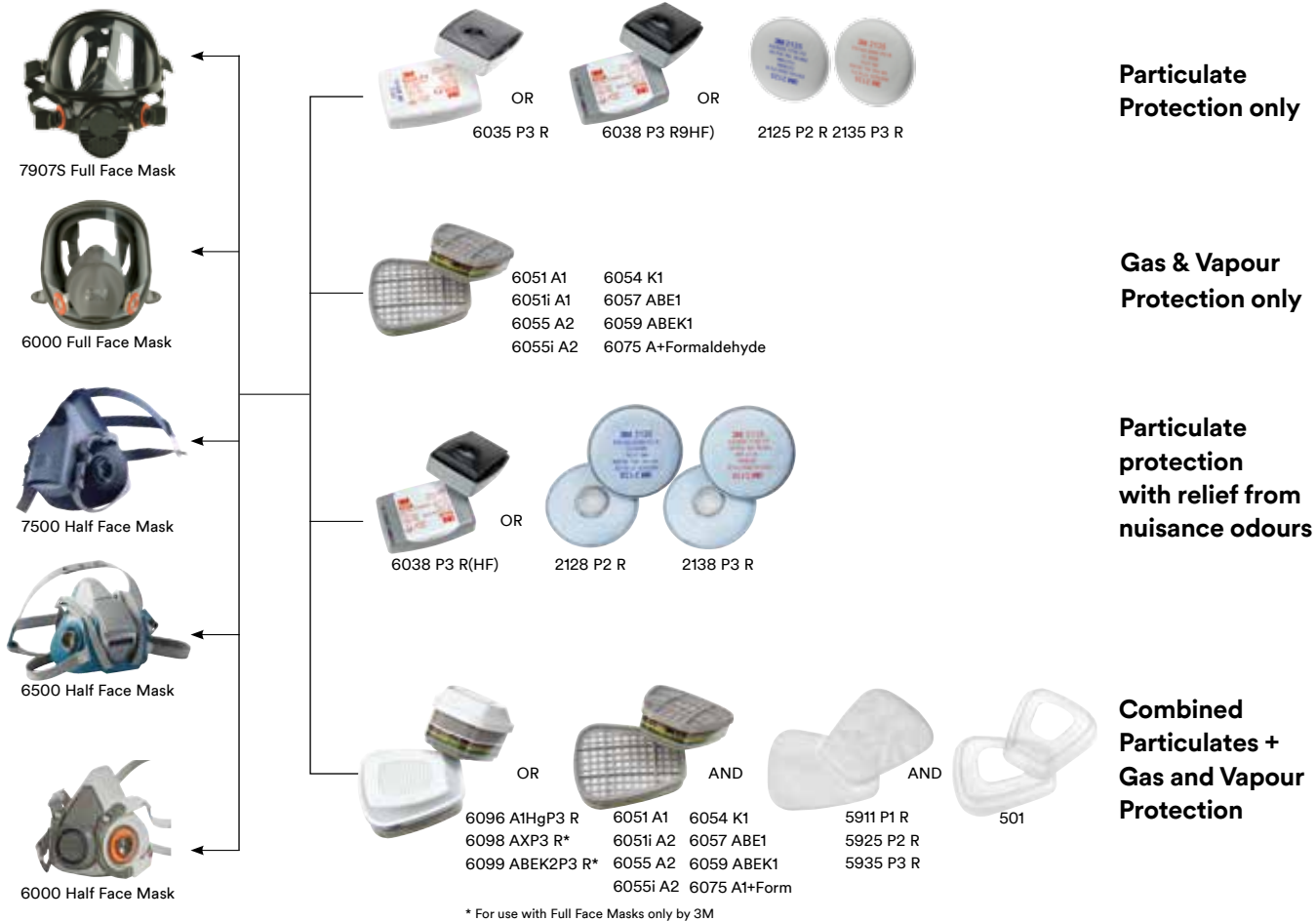

Optional 3M™ S-200+ Supplied Air System compatible with 3M™ Reusable Respirator Series

# 3M™ Reusable Respirators



## 4. Train in Fitting and Use

Make sure you know how to use and maintain your Respiratory Protective Equipment to ensure effective respiratory protection. 3M sales and technical professionals can help you to define your training needs and can provide training and on-site consultations on all aspects of respiratory protection tailored to your individual needs. You'll also find easy to use training on our website: [www.3M.eu/occsafety](http://www.3M.eu/occsafety)

## Reusable Respirator Care & Maintenance

3M™ Reusable Respiratory Equipment requires regular checks and maintenance to ensure optimum performance and protection for the wearer. In addition to potentially reducing protection levels, poor maintenance can also reduce the effective lifetime of the equipment, resulting in the additional cost of replacement. Guidance on the appropriate checks is provided in the instruction booklets with each new item.



## 3M™ 7500 Series Half Mask Cleaning and Inspection

**Before Use**

- Inspect respirator for incorrectly fitted and/or damaged parts. Replace if necessary
- Inspect the exhalation valve and seat. Any damaged or deteriorated valves should be replaced

**Monthly**

- Carry out all the 'Before Use' inspections
- Check:
  - Face Seal
  - Straps and Head harness
  - Valves
- Create record of this monthly check

**After Use**

- Cleaning is recommended after each use
- Remove the gas/vapour and/or particulate filters.
- Clean with 3M 105 wipe or by immersing in warm cleaning solution, water temperature not to exceed 50°C and scrub with a soft brush until clean
- Rinse in fresh warm water
- Air dry in a non-contaminated atmosphere

**Ordering Consumables, Repair Parts and Accessories**  
To request a quote or place an order for these items, please contact your 3M Approved Distributor.

**Further Information and Advice**  
If you require additional guidance on Care and Maintenance of your 3M Reusable Respirators, please contact the helpline.

**3M Health and Safety Helpline**  
0870 60 800 60 (UK)  
1 800 320 500 (Ireland)



3M Part Number	
1	Head Harness 7581
2	Inhale Valve 7562
3	Exhale Valve 7563
4	Filter Holder 7586

**REPLACE ALL DAMAGED PARTS IMMEDIATELY TO ENSURE CORRECT LEVELS OF PROTECTION**

**Occupational Health & Environmental Safety Group**  
3M Respiratory Division P.O. Box 100  
St. Paul, MN 55137  
USA  
Tel: +1 651 436 7000  
www.3M.com/usa/ehs

**Occupational Health & Environmental Safety Group**  
3M Ireland  
3M House, Adgey Centre  
Lough Lurgan, Co. Down, Antrim  
UK, Dublin, Ireland  
Helpline: 1 800 320 500

Product 100000  
Printed in the United Kingdom  
© 2014 3M. All rights reserved.



Example of a 3M™ Reusable Respirator Cleaning and Inspection Sheet



## Respirator Select and Service Life Software

3M have designed state of the art software to help make the selection of 3M™ Respirators and filters easier. The user-friendly software also helps users estimate the service life of 3M™ Gas and Vapour Filters and helps determine how to use the NEW 3M™ 6051i and 6055i filters that feature the 3M™ End of Service Life Indicator (ESLI).

The 3M™ Select and Service Life Software simplifies and speeds up the selection of 3M™ Respirators through a user-friendly interface that allows the user to enter contaminants and their concentrations.

With the ability to analyse more than 700 different chemicals, and mixtures of chemicals, the software provides a series of prompts to the user to select an appropriate respirator. A record is also provided of the choices made by the user.

Respiratory filters have a limited service life, this is the estimated period of time before breakthrough of a chemical for a specific filter. Respiratory protection standards and/or good practice often require users of chemical filter respirators to implement a filter change schedule based on "objective information or data" to help prevent worker overexposure.

The 3M™ Select and Service Life Software offers the additional capability of estimating the frequency of replacement of 3M™ Gas and Vapour Filters. The software calculates service life based on workplace conditions such as contaminant concentration. This information can then be used to establish a filter change schedule.

### ESLI Software



The 3M™ Gas & Vapour Service Life Indicator Filters 6051i and 6055i feature an End of Service Life Indicator (ESLI). The ESLI software can help you determine if you can rely on the ESLI as your primary filter change plan.

### 3M™ Select Software



3M™ Select Software is designed to help you choose the appropriate 3M™ Respirator for your work environment.

### 3M™ Service Life Software



The Service Life calculation is designed to help you estimate the service life of selected 3M™ Gas and Vapour Filters.

To use the software simply visit:  
[www.3M.eu/SLS](http://www.3M.eu/SLS)





## 3M™ Filters for use with Reusable Respirators

3M has developed a broad range of filters for use with its half and full face masks that offer effective protection against gases, vapours and particles. The unique Bayonet Filter Attachment System allows the filters to just be clicked into place ensuring optimum ease of use.

### 3M™ Particulate Filters 2000 Series

Filter	Protection level	Protection against
2125	P2 R	solid and liquid particles
2128	P2 R	solid and liquid particles. Plus ozone protection 10 x nominal protection factor and organic vapours/acid gas
2135	P3 R	solid and liquid particles
2138	P3 R	solid and liquid particles. Plus ozone protection 10 x nominal protection factor and organic vapours/acid gas
502**		filter retainer

### 3M™ Particulate Filters 5000 Series

Filter	Protection level	Protection against
5911†	P1 R	solid and liquid particles
5925†	P2 R	solid and liquid particles
5935†	P3 R	solid and liquid particles
501		filter retainer
603		filter platform

### 3M™ Gas and Vapour Filters 6000 Series

Filter	Protection level	Protection against
6051	A1	organic gases & vapours boiling point (bp)>65°C
6054	K1	ammonia and derivatives
6055	A2	organic vapours bp>65°C
6057	ABE1	organic vapours bp>65°C, inorganic vapours and acid gases
6059	ABEK1	organic vapours (bp>65°C), Inorganic vapours, acid gases ammonia and its derivatives.
6075	A1+ formaldehyde	organic vapours bp>65°C and formaldehyde

### 3M™ Gas, Vapour and Particulate Filters 6000 Series

Filter	Protection level	Protection against
6096	A1 HgP3 R	organic vapours bp>65°C, mercury vapours and particulates
6098*	AXP3 NR	single compound organic vapours (bp<65 °C) and particulates
6099*	A2B2E2K2P3 R	organic vapours, inorganic vapours and acid gases bp>65°C, ammonia, derivatives and particulates

\* Only for full face masks.  
The filters of the 6000 Series conform with the European Standards: EN14387 and/or EN143.



### 3M™ Gas and Vapour Filters with 3M™ Service Life Indicator 6000i Series

Filter	Protection Level	Protection against
6051i	A1	organic gases & vapours bp> 65°C with 3M end of service life indicator
6055i	A2	organic vapours bp> 65°C with 3M end of service life indicator

\* Please see the 6051i and 6055i User Instructions or the 3M™ Select and Service Life Software to determine if these filters are appropriate as a primary change out method for your work environment.

It is important to change your gas and vapour filters at the right time; using the filter for longer can lead to break-through of hazard into the mask. Service life is the term used to describe how long a set of filters can be used before they need to be changed.

\*The ESLI is only appropriate as a primary change out method for certain organic vapours and exposure concentrations, must also be less than the workplace exposure limit (WEL).

### 3M™ Particulate Filters 6035/6038 Series

Filter	Protection level	Protection against
6035	P3 R	solid and liquid particles – in solid plastic case for rough application
6038	P3 R	solid and liquid particles. Hydrogen Fluoride gas up to 30 ppm and relief from nuisance level organic vapours and acid gases below nominal protection factor in solid plastic case for tough applications
502**		filter retainer

\*\* 502 filter retainer, allows 6000 series Gas and Vapour filters to be combined with 2000 series or 6000 series particulate filters.

† 5000 series filters can be used with 6000 series filters for combined gas and particulate protection in conjunction with a 501 filter retainer, and without the 6000 series filters in conjunction with a 603 filter platform and a 501 filter retainer.



## 3M™ Organic Gas & Vapour Service Life Indicator Filters – 6000i Series Filters

Proudly introducing the 3M™ Organic Gas & Vapour Filters with 3M™ Service Life Indicator technology.

Unique to 3M, these innovative and easy-to-use filters have an end-of-service-life indicator (ESLI) to help users to determine when to change their filters in appropriate environments\*.

Compatible with any 3M Reusable mask, apart from the 4000 Series, the 6051i and 6055i filters can be used to complement or replace your current filter change schedule.

### Features and Benefits:

- Designed to indicate service life based on individual exposure and respiratory use patterns
- An efficient and effective visual tool to help determine when to change filters
- Helps provide added peace of mind, and can help increase compliance with your company's respirator policy and industry regulatory requirements
- CE approved as A1 (6051i) and A2 (6055i) organic vapour filters against certain organic gases and vapours PLUS all of the features you would find in standard 3M Gas & Vapour Filters

#### Simple indicator bar

Helps users determine when to change filters.

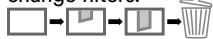

#### Removable label

Helps protect Indicator from overspray and debris.



### 3M™ Organic Gas and Vapour Service Life Indicator Filter 6051i

### 3M™ Organic Gas and Vapour Service Life Indicator Filter 6055i



### Who can benefit?

The 3M Service Life Indicator can be used to complement or replace your current filter change schedule. It is only recommended as a primary change method for certain organic vapours and exposure levels.

To determine if the ESLI may be used as the primary method for determining your filter schedule:

- 1 Perform exposure monitoring to quantify the organic vapour exposure levels in your workplace (See [www.3M.co.uk/exposedetection](http://www.3M.co.uk/exposedetection) for guidance).
- 2 Enter the monitoring results in the 3M™ Select and Service Life Software ([www.3M.co.uk/filterservicelife](http://www.3M.co.uk/filterservicelife)). If the ESLI is not applicable as a primary method, it may still be used to complement your current filter change schedule.

It is important to change your gas and vapour filters at the right time; using the filter for longer can lead to break through of hazard into the mask. Service Life is the term used to describe how long a set of filters can be used before they need to be changed.

The ESLI is only appropriate as a primary change out method for certain organic vapours and exposure concentrations must also be less than the workplace exposure limit (WEL)

\*Please see the 6051i and 6055i User Instructions or the 3M™ Select and Service Life Software to determine if these filters are appropriate as a primary change out method for your work environment.





## 3M™ Maintenance Free Reusable Respirators 4000 Series

Since its introduction, the 3M 4000 Series has been the first choice 3M Reusable Respirator by health and safety managers across Europe\*. With no parts assembly or maintenance required this simple, lightweight, well balanced respirator offers reliable respiratory protection against a range of gases, vapours and particulates typically found in a variety of industries. A unique bonded carbon technology allows the respirator to sit close to the face and fit well under many other types of protective equipment, providing an undisturbed field of vision and a more comfortable worklife.

### Features and Benefits:

#### Comfortable, Effective Protection

- Low profile design for better peripheral vision
- Lightweight, well balanced design
- Soft, non-allergenic material with textured face seal
- Proven to consistently exceed EU standard requirements for breathing ease<sup>1</sup>

#### Convenience

- One piece, maintenance-free construction
- Four versions available, each offering protection against differing hazards throughout industry
- Resealable bag provides convenient and clean storage between uses

#### Cooler Wear

- Central position of the exhalation valve for effective removal of heat and moisture build up within face piece

#### Adjustability

- Helps to achieve a stable secure fit
- Easy to fasten neck strap

#### Cost Effective

- Use until damaged, particulate filters clog or gas filters become saturated
- Proven to consistently exceed minimum standards for filter service life<sup>2</sup> which can help postpone the need for respirator replacement and, overtime, represent a budget gain

#### Accessories

- 3M™ Overspray Guard 400 is available to help prolong the life of the main particulate filters

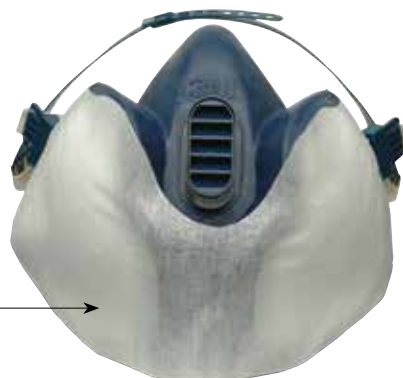
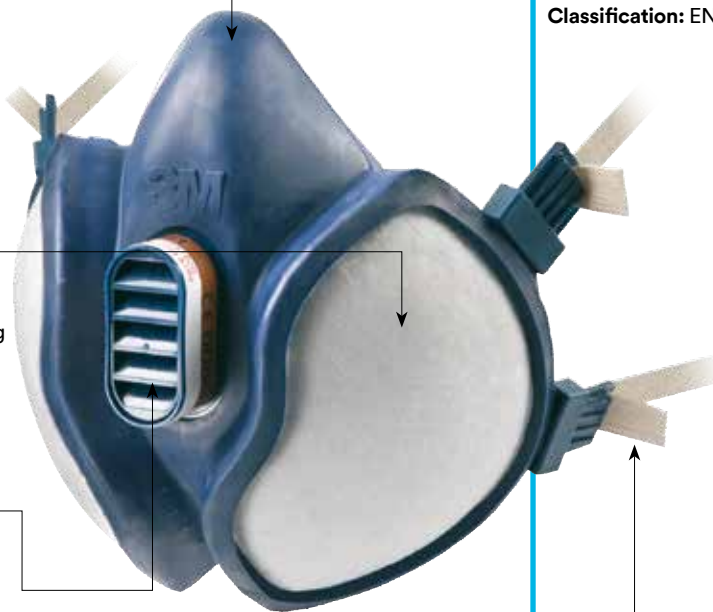

**3M™ Maintenance Free Respirator 4251**  
**Classification: EN405:2001+A1:2009**

#### Compatible with:

- Eyewear from 3M
- Hearing Protection from 3M

**3M™ Maintenance Free Respirator 4000 series available:**

**3M™ Reusable Respirator 4251**  
 Organic Vapour\* + Particulates  
 FFA1P2 R D

**3M™ Reusable Respirators 4255**  
 Organic Vapour\* + Particulates  
 FFA2P3 R D

**3M™ Reusable Respirator 4277**  
 Organic Vapour\* / Inorganic Vapours + Acid Gas / Particulates  
 FFABE1P3 R D

**3M™ Reusable Respirator 4279**  
 Organic Vapour\* + Inorganic Vapours + Acid Gas / Ammonia / Particulates  
 FFABEK1P3 R D

\*Based on sales of 3M reusable respirators in Europe Middle East and Africa between 2010 and 2013.

<sup>1</sup>INSPEC INTERNATIONAL Test Report 1.10.06.29 and ongoing quality release data

<sup>2</sup>Tested by 3M, ongoing quality release data. For example in 2012: 300 products tested, all samples exceeded EN 405 minimum level gas and vapour filter capacity.

\* Organic vapours boiling point>65 degrees C



## 3M™ Reusable Half Masks 7500 Series

The 7500 Series Respirators by 3M have set a new standard in comfort. This facepiece was designed with the wearer in mind. Its soft sealing surface, along with the unique 3M™ Cool Flow™ Valve, enhances wearer comfort and face fit. Reduced breathing resistance helps to minimise heat build-up in the mask and increases your comfort.

Available in three sizes, all masks have the 3M™ Bayonet Attachment System offering a broad range of twin lightweight filters to protect against gases, vapours and particulates depending on your individual needs and can also be used with 3M™ Supplied-Air Systems.

### Features and Benefits:

#### Head Harness

- Balanced, secure fit
- Reduced pressure and tension points

#### Facepiece

- DropDown feature for added convenience during breaks
- Designed for compatibility with 3M Head and Eye protection
- Soft silicone face piece material for comfort and durability
- Thin nose bridge area for more comfort
- Fully maintainable
- Low weight of 136 gr.

#### 3M™ Cool Flow™

##### Exhalation Valve

- Less exhalation resistance
- Easier breathing
- Less heat and sweat build-up
- Reduces valve vibration
- Downwards flow of exhaled air
- Stays clean



#### Low-Profile Design

- Minimises interference with field of view
- Minimised dirt-traps
- Reduced fogging with eye protection
- Sleek look and feel

#### Filter Connection

- Twin filter design provides lower breathing resistance
- Better weight distribution and more balanced fit
- Improved peripheral vision
- Safe and secure fit
- Optical marking of attachment point
- Flexible System for gas, vapour, particulate filters
- Optional supplied-air connection

#### Plus

- Full range of spares available
- Available in three sizes distinguished by different colours



#### 3M™ Half Mask 7503 (Large)

Classification: EN140:1998

3M™ Half Mask 7501 – small (grey blue)

3M™ Half Mask 7502 – medium (light blue)

3M™ Half Mask 7503 – large (dark blue)

#### Compatible with:



- 3M™ S-200+ Supplied Air System
- 3M Protective Eyewear
- 3M Hearing Protection

#### Ready-to-Use Respirator Packs

##### 3M™ Reusable Half Masks 7500 Series



See page 47 for 3M™ Half Mask Accessories



## 3M™ Reusable Half Masks 6500 Series

The 3M™ Reusable Half Masks 6500 Series have been designed with tough and dirty work environments in mind. Stay productive and protected – the 6500 Series delivers durability and stability with a firm, lightly textured silicone faceseal and strong body construction. There are two versions of the 6500 Series available - the 6500QL Series featuring the Quick Latch Drop Down mechanism and the 6500 Series (Standard). Both versions are available in three sizes.

### Features and Benefits:

#### Overmoulded, Low-Profile Design

- Simplified cleaning and maintenance with minimal parts and crevices
- Advanced half mask design for a wide field of view
- Compatibility with 3M™ welding/grinding shields

#### Adjustable Head Harness Assembly

- Optimum fit and comfort with three-size adjustable head cradle
- Durable harness straps

#### Silicone Faceseal

- Provides comfort and stability with a soft but firm faceseal
- Extended product life due to resilient silicone material
- Lightweight
- Keeps its shape in high-heat environments
- Available in three sizes (S, M and L)

#### 3M™ Bayonet Connection

- Flexible bayonet system for connection to a wide range of 3M™ gas, vapour and particulate filters

#### Valve Cover Design

- Directs exhaled breath and moisture downward
- Easy positive pressure seal check

#### 3M™ Cool Flow™ Exhalation Valve

- Enhanced comfort by reducing heat and moisture
- Less exhalation resistance makes breathing easier

#### Quick Latch (QL) - Drop Down Mechanism\*

- Easy on and off as you move in and out of contaminated areas
- No need to remove your safety helmet or face shield when lowering or raising your respirator

\*QL version only

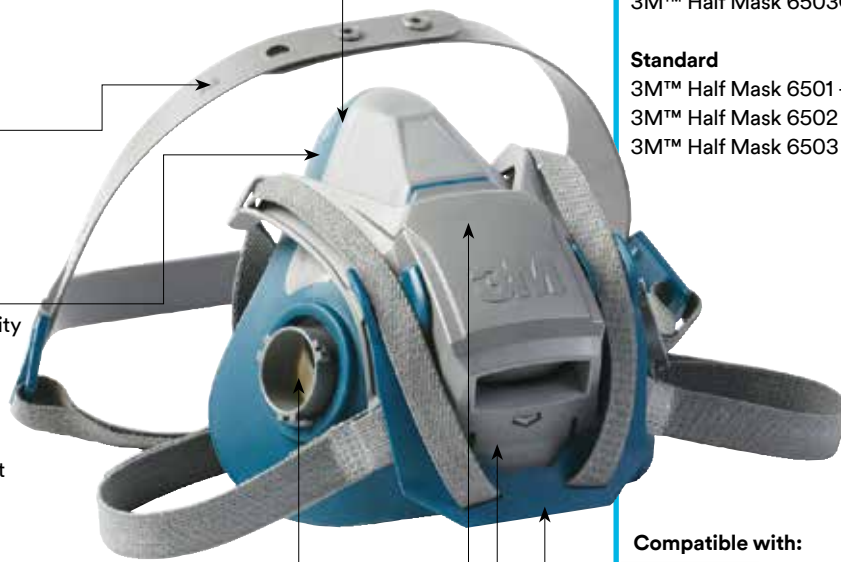

#### 3M™ Reusable Half Mask 6501QL - small with Quick Latch

- 3M™ Half Mask 6501QL - small
- 3M™ Half Mask 6502QL - medium
- 3M™ Half Mask 6503QL - large

#### Standard

- 3M™ Half Mask 6501 - small
- 3M™ Half Mask 6502 - medium
- 3M™ Half Mask 6503 - large

#### Compatible with:



- 3M™ S-200+ Supplied Air System
- 3M Protective Eyewear
- 3M Hearing Protection

See page 47 for 3M™ Half Mask Accessories



## 3M™ Reusable Half Masks 6000 Series

The 3M™ Reusable Half Masks 6000 Series are economical, low-maintenance, simple to handle and lightweight. Available in three sizes, all masks have the 3M™ Bayonet Connection System allowing connection to a broad range of twin filters to protect against gases, vapours and particulates depending on your individual needs. 6000 series half masks by 3M can also be used with 3M™ Supplied Air Systems for your increased convenience and flexibility

### Features and Benefits:

#### Head Harness

- Designed for compatibility with other 3M Head and Eye protection
- Cradle suspension for comfortable fit
- Easy to fasten neck strap

#### Facepiece

- Three colour coded sizes for easier identification
- Lightweight elastomeric material for comfort during long periods of work
- Ultra-low weight of 82g
- Reducing maintenance costs to minimum

#### Low-Profile Design

- Minimises interference with field of view
- More simplicity for easy handling

#### Filter Connection

- Twin filter design provides lower breathing resistance
- Better weight distribution and a more balanced fit
- Improved peripheral vision
- Safe and secure fit
- Optical marking of attachment point
- Flexible System for gas, vapour, particulate filters
- Optional supplied-air connection

#### Plus

- Spare parts available
- Available in three sizes distinguished by different colours



#### 3M™ Half Mask 6200 (Medium)

Classification: EN140:1998

- 3M™ Half Mask 6100 – small (light grey)
- 3M™ Half Mask 6200 – medium (grey)
- 3M™ Half Mask 6300 – large (dark grey)

#### Compatible with:

- Eyewear from 3M
- Hearing Protection from 3M

#### Accessories for 3M Half Masks



3M™ Half Mask Carry Bag 106



3M™ Face Seal Wipe 105

#### Ready-to-Use Respirator Packs

#### 3M™ Reusable Half Masks 6000 Series





## 3M™ Reusable Full Face Mask 7907S

The 3M™ Full Face Mask 7907S offers durability and safety for demanding tasks that require face and respiratory protection. The 3M™ Bayonet Connection System offers a broad range of twin lightweight filters to protect against gases, vapours and particulates depending on your individual needs.

The 7907S full face mask by 3M can also be used with Supplied Air Systems by 3M for your increased convenience and flexibility.

### Features and Benefits:

#### Six Strap Head Harness

- Easy and secure fit for maximum safety
- Provides greater stability
- Easy release buckles

#### Full Face Lens

- Large polycarbonate lens with wide field of view
- Spectacle kit and lens covers available

#### Facepiece

- Double face sealing for safe, secure fit to most face sizes
- 6 Strap suspension
- Silicone rubber one-size-fits-all
- Highly durable
- Range of consumables available
- Speech Diaphragm for improved communication

#### Filter Connection

- Twin filter design provides lower breathing resistance
- Better weight distribution and more balanced fit
- Improved peripheral vision
- Safe and secure fit
- Flexible System for gas, vapour, particulate filters
- Optional supplied-air connection



#### 3M™ Full Face Mask 7907S (Silicone)

Classification: EN136 (Class 2)

#### Compatible with:

- Hearing Protection from 3M

#### Accessories for 3M™ Full Face Masks



3M™ Face Seal Wipe 105



3M™ Full Face Carry/Storage Bag 107



## 3M™ Reusable Full Face Masks 6000 Series

The 3M™ Full Face Masks 6000 Series are simple to handle and comfortable to wear. The exhalation port provides increased durability and is easy to keep clean. Available in three sizes, all masks have the 3M™ Bayonet Connection System enabling connection to a broad range of twin lightweight filters to protect against gases, vapours and particulates depending on your individual needs.

### Features and Benefits:

#### Full Face Piece

- Soft, non-allergenic elastomeric face piece
- Extremely lightweight (400 grams) for high comfort

#### Full Face Lens

- Broad field of vision
- Polycarbonate lens, scratch and impact resistant to EN166:2001 B

#### 4 Strap Head Suspension

- Easy to put on and take off
- Well balanced

#### 3M™ Cool Flow™

##### Exhalation Valve

- Less exhalation resistance
- Easier breathing
- Less heat and sweat build-up
- Reduces valve vibration
- Downwards flow of exhaled air
- Minimised dirt-traps to stay clean
- Sleek look and feel

#### Filter Connection

- Twin filter design provides lower breathing resistance
- Better weight distribution and more balanced fit
- Improved peripheral vision
- Safe and secure fit
- Optical marking of attachment point
- Flexible System for gas, vapour, particulate filters
- Optional supplied-air connection

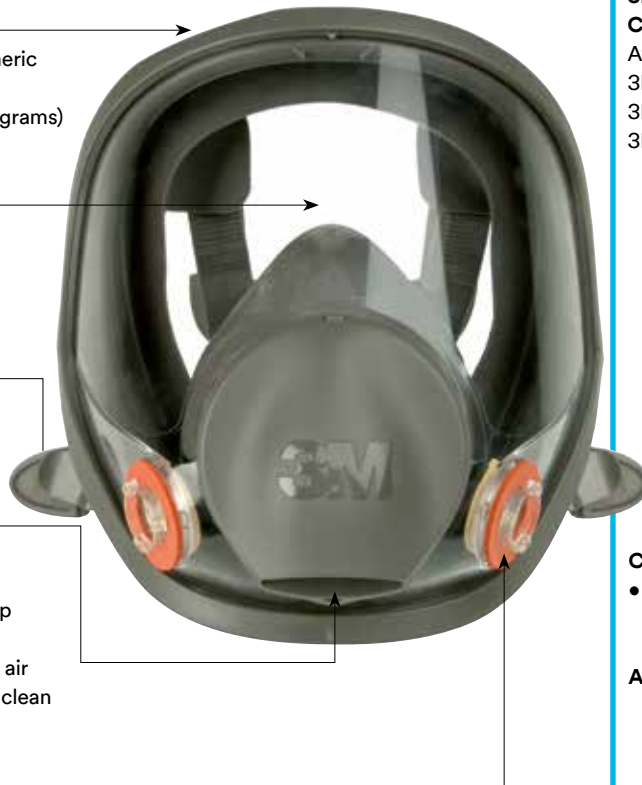

### 3M™ Full Face Mask 6800 (Medium)

**Classification:** EN136:1998 (Class 1)

Available in three sizes:

3M™ Full Face Mask 6700 - small

3M™ Full Face Mask 6800 - medium

3M™ Full Face Mask 6900 - large

#### Compatible with:

- Hearing Protection from 3M

#### Accessories for 3M™ Full Face Masks



3M™ Face Seal Wipe  
105



3M™ Full Face Carry/  
Storage Bag 107

## Reusable Respirator Spares and Accessories

### Half Masks

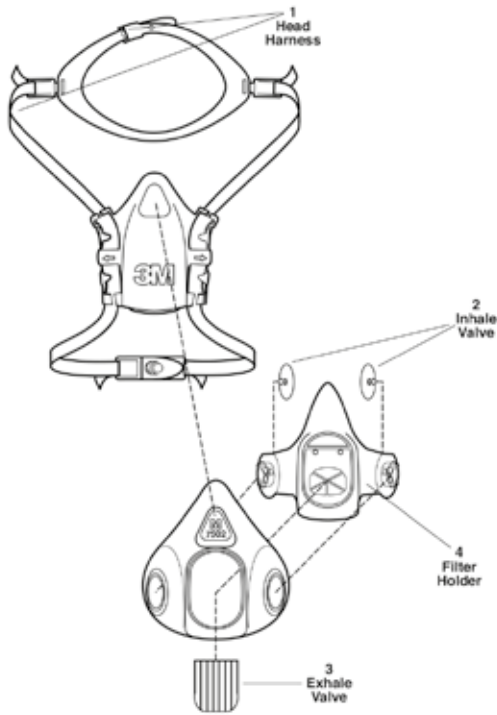

**3M™ 7500 Series Half Mask**

#	Description	Part Number
1	Head Harness	7581
2	Inhalation Valve	7582
3	Exhalation Valve	7583
4	Filter Holder	7566

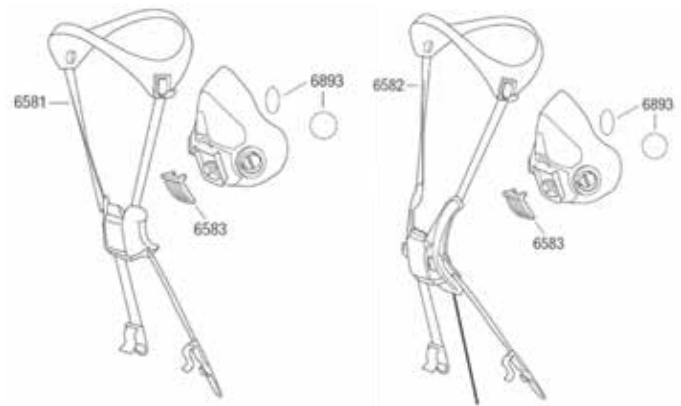

**3M™ 6500 and 6500QL Series Half Masks**

#	Description	6500 Part Number	6500QL Part Number
1	Head Harness Assembly/ Quick Latch Head Harness Assembly	6581	6582
2	Exhalation Valve	6583	6583
3	Inhalation Valve	6593	6893



**3M™ 6000 Series Half Mask**

Description	Part Number
Inhalation Valve Gasket	6895

## Reusable Respirator Spares and Accessories

### Full Masks

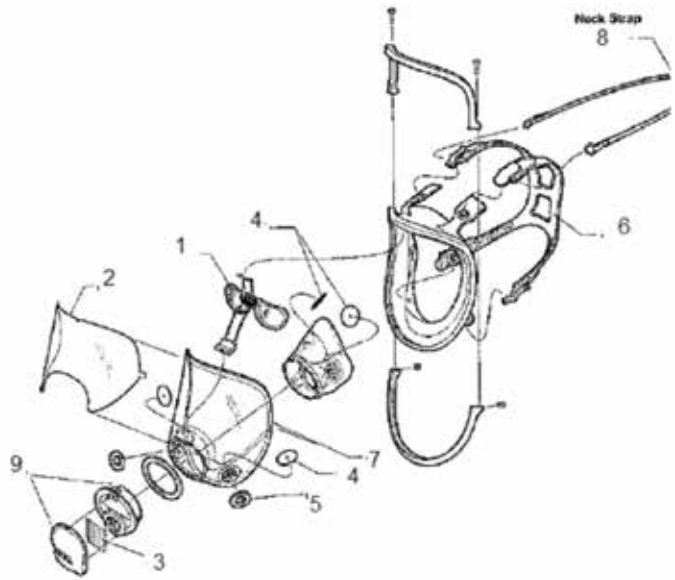

**3M™ 7907S Series Full Face Mask**

#	Description	Part Number
1	Speaking Diaphragm Kit	7895
2	Breathing Room Assembly	7924
3	Nose Cup Assembly	7991
4	Exhalation Valve Cover	7918
5	Nose Cup Valve Assembly	7882
6	Lens Covers	7992
7	Lens Frame Kit	7928
8	Large Respirator Rubber	7003

**3M™ 6000 Series Full Face Mask**

#	Description	Part Number
1	Spectacle Kit	6878
2	Lens Cover Peek Off	6885
3	Exhalation Valve	6889
4	Inhalation Valve	6893
5	Inhalation Gasket	6895
6	Head Harness Assembly (including head harness and buckles)	6897
7	Lens Assembly (including lens, bayonet part fittings, inhalation valves and inhalation port gaskets)	6898
8	Neckstrap Assembly	7883
9	Centre Adapter Assembly	6864